



MDC
— Depuis 1947 —

FI 25 BET



2026-03

Gamme de produits
Meubles de salle de bains

NOS GAMMES



ODYSSÉE



ALTITUDE



REFLET

GAMME ODYSSEE



GAMME ODYSSEE

Sous-vasque

L.60

L.80

L.90

L.100

L.120

1 porte

H.60 – P.45,5

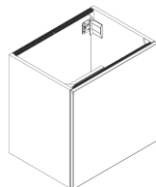

2 portes

H.60 – P.45,5

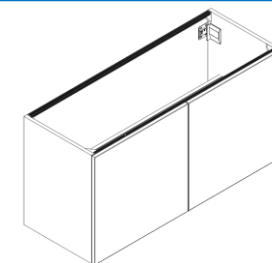
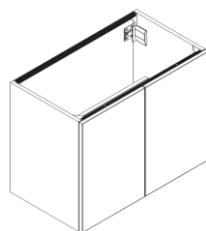
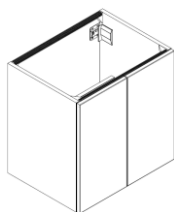

1 tiroir

H.30 – P.45,5

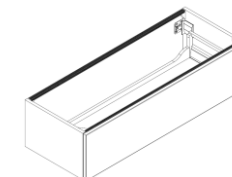
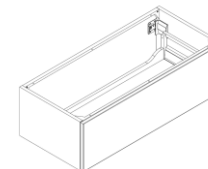
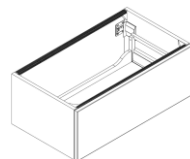
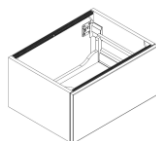

2 tiroirs

H.60 – P.45,5

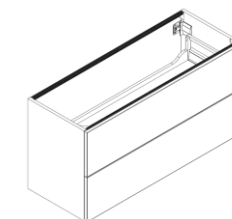
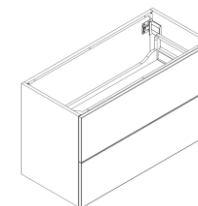
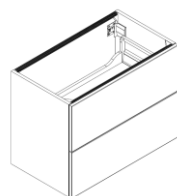
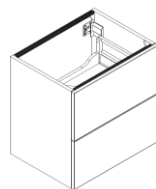

3 tiroirs

Posé au sol

H.90 – P.45,5



GAMME ODYSSEE

Sous-vasque

L.60

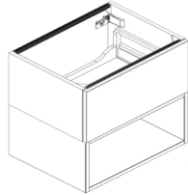

L.80

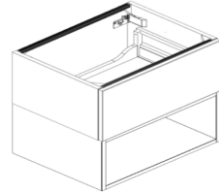

L.90

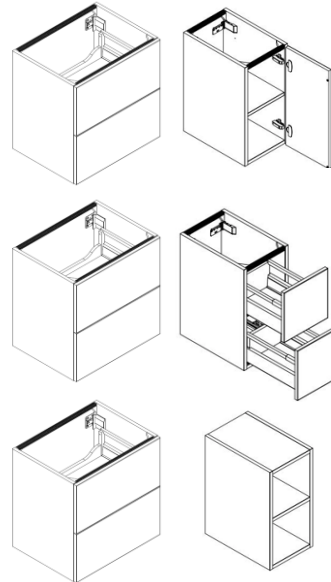

L.100

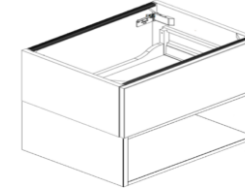

L.120



Combiné

H.60 – P.45,5

Lave-mains

L.40

H.60 – P.20

Vasque résine incluse

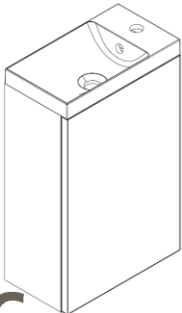

Habillage bâti WC

L.60

H.130 – P.24,5

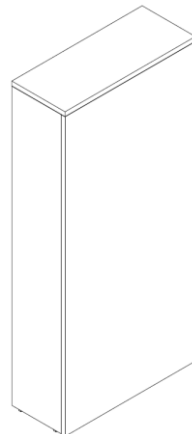

Colonne

L.35

H.160 – P.38

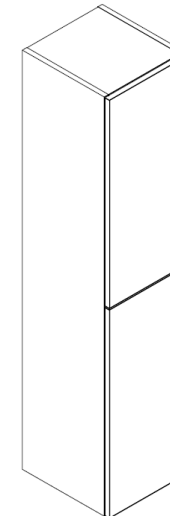

2 portes

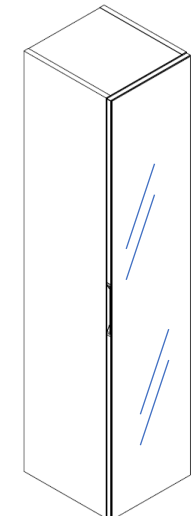

1 porte miroir

GAMME ODYSSEE

Plan vasque

L.60

L.80

L.90

L.100

L.120

Céramique
Brillante
Blanche



Vasque à gauche



2 robinets



Vasque à gauche



Vasque à gauche

Céramique
Mate
Blanche



Résine
Brillante
Blanche



2 robinets



2 robinets

Plan
mélaminé

Assorti aux meubles



Vasque à poser
Céramique blanche
Ø36 H.12



*Equerre de renfort
pour plans mélaminés dès L80*

GAMME ODYSSEE

L.40

L.60

L.80

L.90

L.100

L.120

Armoires de toilette

*Bandeau lumineux
Prise électrique
Miroir intérieur*

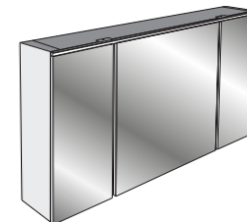
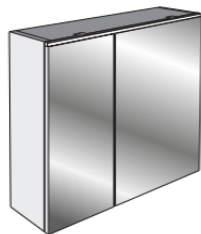

Miroirs

Tablette
pour miroir

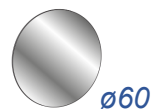
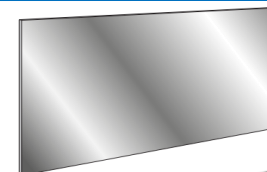
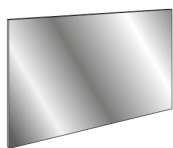

ø60

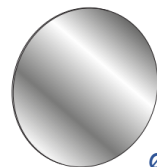

ø90

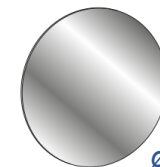

ø90

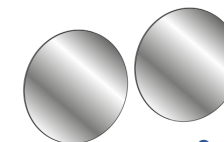

2 x ø60



L.50 x H.90



L.90 x H.50

Eclairage

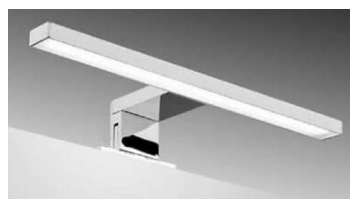

L. 30 / 50 / 80

**Pour plus de détails sur
l'éclairage voir la
Gamme REFLET**

GAMME ODYSSÉE

Poignées

Poignée rapportée
Poignée à commander à part
Meuble non percé



Styles et décors au choix

Poignée sur chant
Poignée à commander à part
Poignées existantes dans toutes les largeurs
de meubles



Blanc



Doré

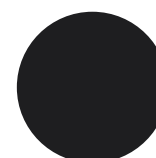

Noir



Effet Inox

Poignée intégrée
Poignée collée sur la porte
Modèle PRO



Blanc



Doré

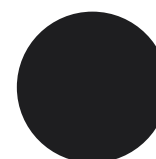





Noir



Effet Inox

GAMME ODYSSEE

Finitions

	Finitions	Modèle	Modèle PRO
		  <p>Poignées à commander à part</p>	
MELAMINE UNI	Uni satiné 	MEL1 MELA UNI Tarif A0	MEL3 MELA UNI POIGNEE PRO Tarif A1
MELAMINE DECOR	Décors bois et effet matière 	DEC1 MELA DECOR Tarif C0	DEC2 MELA DECOR POIGNEE PRO Tarif C1
MELAMINE VERNI	Mat et Brillant 	VER1 MELA VERNI Tarif E0	VER3 MELA VERNI POIGNEE PRO Tarif E1

Intérieur : Finition Anthracite

Délais (livraison à la commande) : 4 semaines votre plateforme logistique

GAMME ODYSSEE

– Mélaminé uni

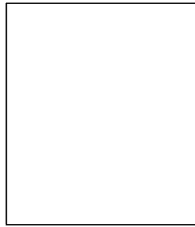

Blanc
W1000ST9 - BLS

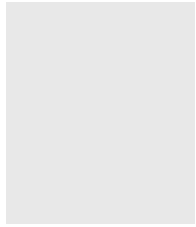

Gris Lumière
U708ST9 - GLS



Nuage
U788ST9 - NUS



Caviar
U963ST9 - CVS



Ivoire
U702ST9 - IVS

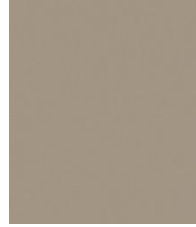

Cappuccino
U727ST9 - CPS



Terracotta
U4436VL - TRS



Fjord
U636ST9 - FJS



Vert sauge
U638ST9 - VSS



Olive
U2508VL - OLS

Façade :

Épaisseur 19mm en PPSM (panneau de particules surfacé mélaminé)

4 chants plaqués assortis d'épaisseur 1mm

Finition mate

Contreface assortie

GAMME ODYSSEE

Mélangé décor



Chêne nature
H3131ST12 - CNV



Chêne sable
H3309ST28 - SAV



Chêne noisette
H1386ST40 - HAV



Chêne Raphia
H1180ST37 - RAV



Béton Clair
F186ST9 - BEC



Ardoise Anthracite
F628ST16 - AAN

Façade :

Épaisseur 19mm en PPSM (panneau de particules surfacé mélaminé)

4 chants plaqués assortis d'épaisseur 1mm

Finition mate

Contreface assortie

SENS DU FIL

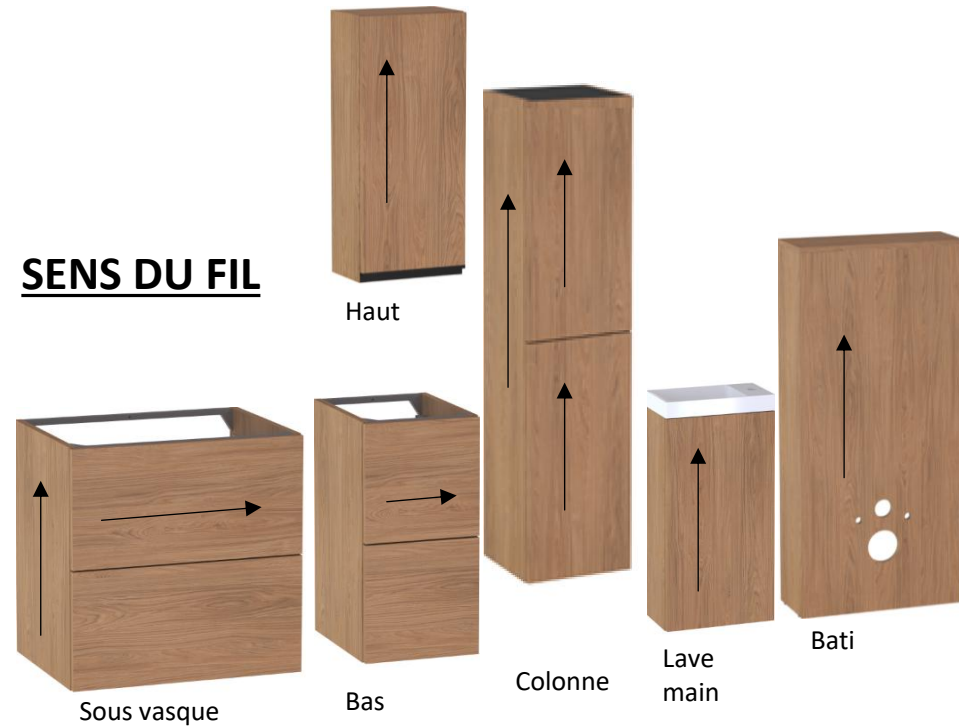

GAMME ODYSSEE

Mélangé verni

Mat



*Blanc mat
(polaire) - BEM*

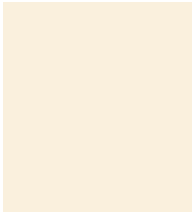

*Crème mat #
ESM*

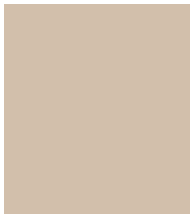

*Ivoire mat *
IVM*



*Gris lune mat
GLM*



*Noir mat
NEM*



*Basalte mat
TSM*



*Camel mat
CSM*



*Indigo mat
ISM*



*Feuille mat
VSM*



*Eucalyptus mat *
U604PM - EUM*

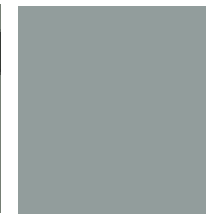

*Fjord mat *
U636PM - FJM*

Brillant



*Blanc brillant
(polaire) - BEB*



*Crème brillant
ESB*



*Ivoire brillant *
U705PG - IVG*

Façade :

Épaisseur 18 ou *19 mm en MDF (panneau de fibre de moyenne densité ou #panneau de particule)

Parement verni (1 couche de laque rideau PU 110g/m² séchage UV)

Contreface assortie

4 chants plaqués assortis d'épaisseur 1mm

GAMME ODYSSEE

Pieds (vendus séparément)

Pied épingle

Hauteur 29cm
Acier Laqué
Lot de 2 pieds



Blanc



Doré



Noir



Effet Inox



Blanc



Doré



Noir



Effet Inox



ACCESSOIRES DE RANGEMENTS

Accessoirisation

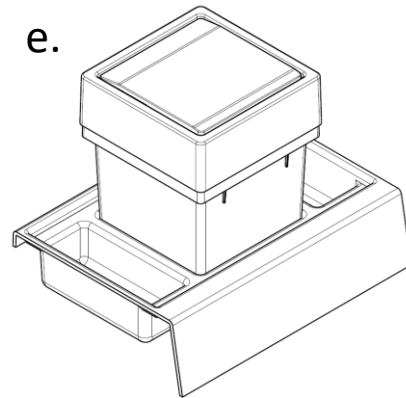
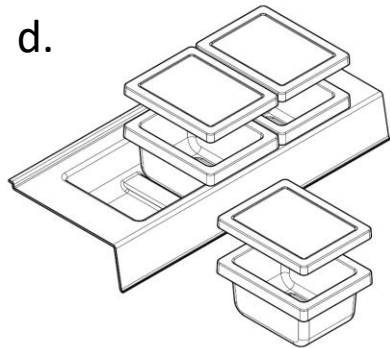
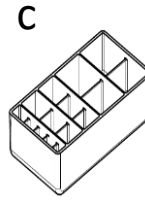
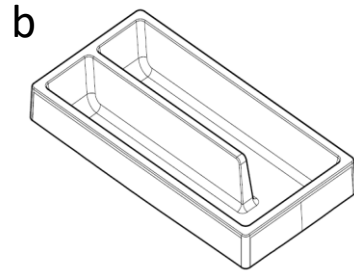
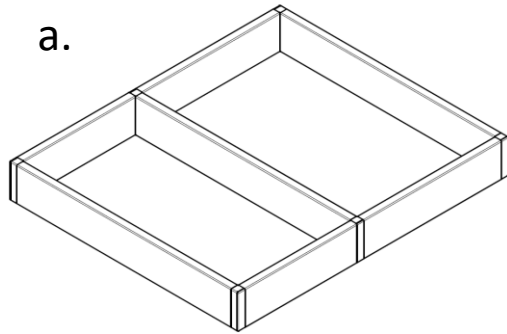

Anthracite

- a. Séparateur de tiroir : idéal pour délimiter l'espace de chacun
- b. Porte-objets : peut contenir tout type d'objet du peigne au rasoir en passant par vos tubes de crème
- c. Porte cosmétiques : reçoit tous vos cosmétiques
- d. Set de 3 boîtes + son support : les 3 boîtes sont équipées d'un couvercle et placées sur un plateau Parfait pour ranger et protéger vos bijoux
- e. Poubelle 5L + support : se fixe sur la façade. Sa petite taille lui permet de se glisser partout



SIPHON GAIN DE PLACE



Tiroir utile sur toute la largeur
=> Siphon gain de place à
commander à part

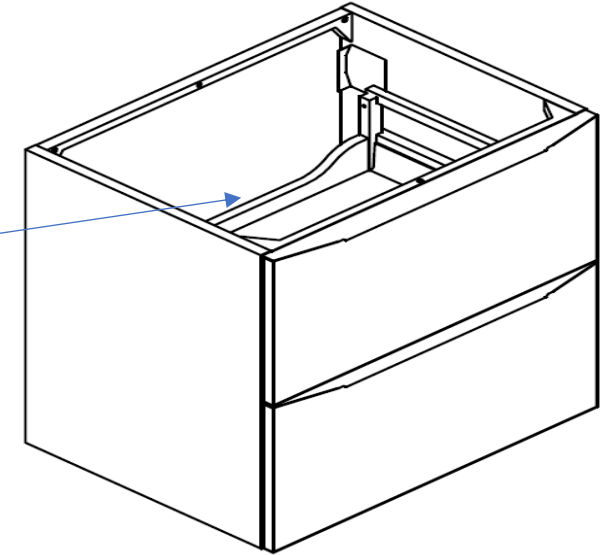

Siphon gain de place - clic-clac
Avec 3 couleurs de bonde au choix

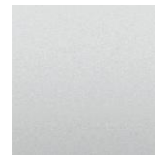

Inox

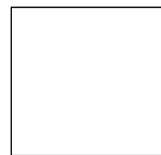

Blanc



Noir

GAMME ALTITUDE



GAMME ALTITUDE

L80

L120

Sous-vasque

H46 – P45,5

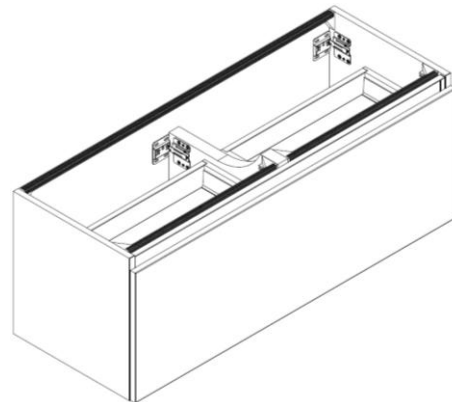
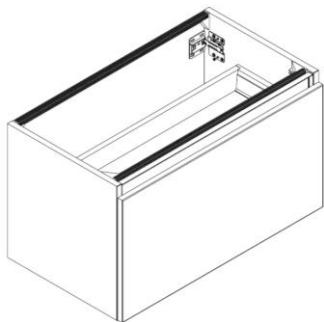

Plan vasque

Résine acrylique
matte

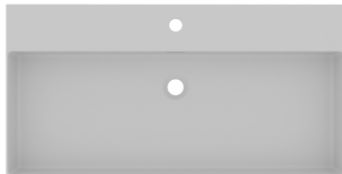

2 robis

Colonne

L40 – P45,5

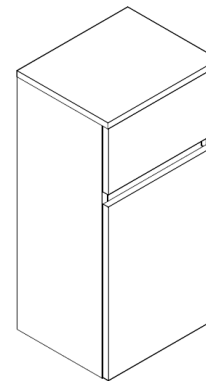

Demi-colonne

L.40 H.80

1 tiroir en partie haute
1 porte avec 1 tablette

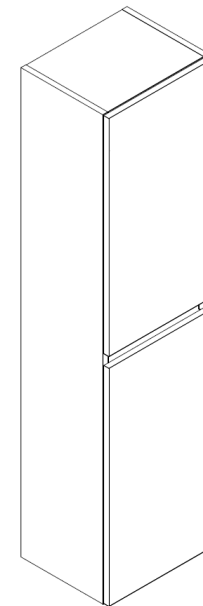

Colonne

L.40 H.160

2 portes avec tablettes



GAMME ALTITUDE

L80

L120

Armoires
de toilette

*Bandeau led
Prise électrique*

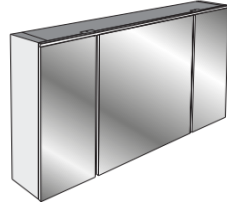

Miroirs

Tablette
pour miroir

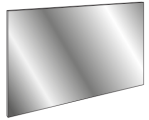

+ tablette L80



+ tablette L120

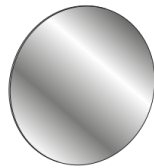

D90

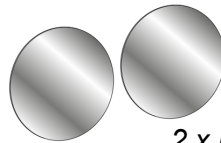

2 x D60



90x50

Eclairage

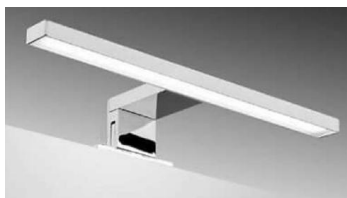



L. 30 / 50 / 80

**Pour plus de détails voir la
Gamme REFLET**

GAMME ALTITUDE

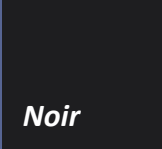
Finitions

Finitions		Profil intégré
MELAMINE VERNI	Vernis mats Vernis brillants Voir annexe pour le détail des finitions	 Noir
		ALT MELA VERNI Profil noir

Intérieur : Finition Anthracite

Délais (livraison à la commande) : 4 semaines votre plateforme logistique

Profil noir



GAMME ALTITUDE – ZOOM SUR LES FINITIONS

— Mélaminé verni

Mat

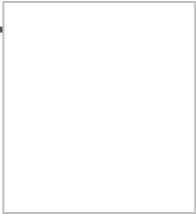

*Blanc mat
(polaire) - BEM*

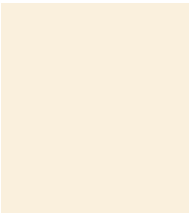

*Crème mat #
ESM*

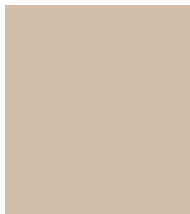

*Ivoire mat *
IVM*



*Gris lune mat
GLM*



*Noir mat
NEM*



*Basalte mat
TSM*



*Camel mat
CSM*



*Indigo mat
ISM*



*Feuille mat
VSM*



*Eucalyptus mat *
U604PM - EUM*

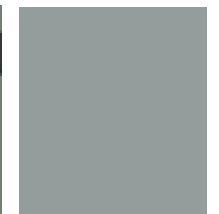

*Fjord mat *
U636PM - FJM*

Brillant



*Blanc brillant
(polaire) - BEB*



*Crème brillant
ESB*



*Ivoire brillant *
U705PG - IVG*

Façade :

Épaisseur 18 ou *19 mm en MDF (panneau de fibre de moyenne densité ou #panneau de particule)

Parement verni (1 couche de laque rideau PU 110g/m² séchage UV)

Contreface assortie

4 chants plaqués assortis d'épaisseur 1mm

ACCESSOIRES DE RANGEMENT

Accessoirisation

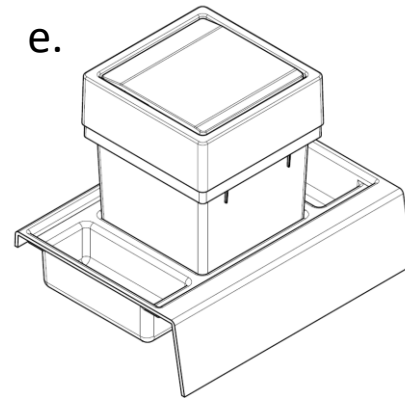
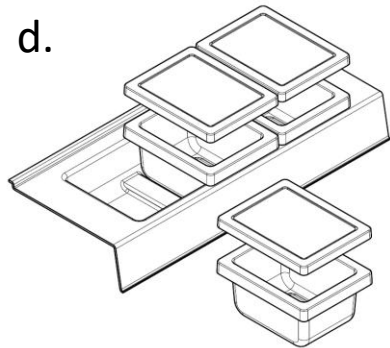
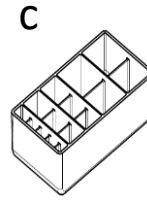
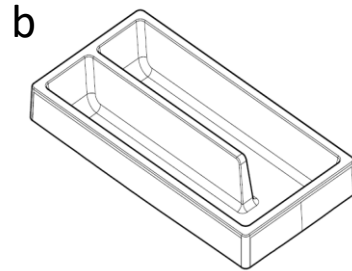
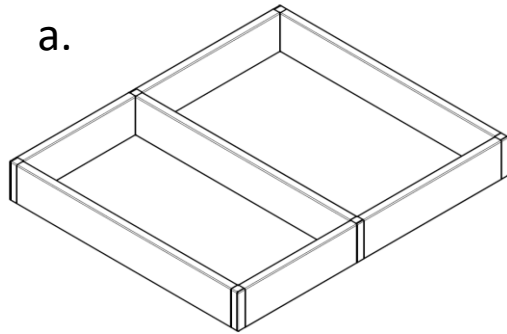

Anthracite

- a. *Séparateur de tiroir : idéal pour délimiter l'espace de chacun*
- b. *Porte-objets : peut contenir tout type d'objet du peigne au rasoir en passant par vos tubes de crème*
- c. *Porte cosmétiques : reçoit tous vos cosmétiques*
- d. *Set de 3 boîtes + son support : les 3 boîtes sont équipées d'un couvercle et placées sur un plateau. Parfait pour ranger et protéger vos bijoux*
- e. *Poubelle 5L + support : se fixe sur la façade. Sa petite taille lui permet de se glisser partout*



SIPHON

Avantage sans découpe de siphon



Tiroir utile sur toute la largeur
=> Siphon gain de place à commander à part

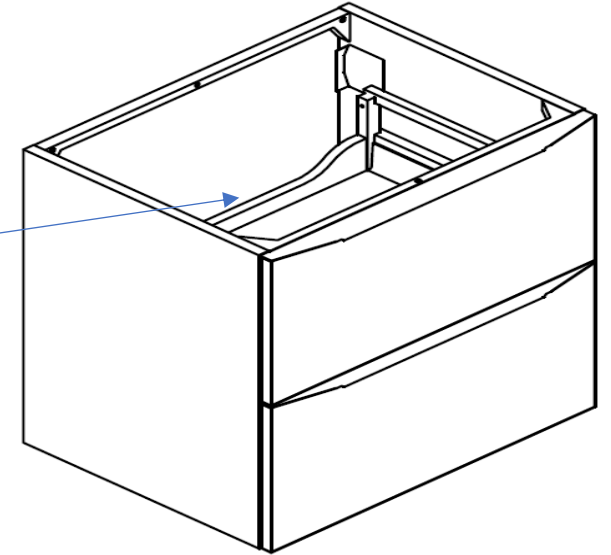

Siphon gain de place - clic-clac
Avec 3 couleurs de bonde au choix

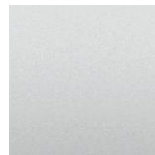

Inox



Blanc



Noir

GAMME REFLET



ARMOIRES, MIROIRS ET ECLAIRAGES

GAMME REFLET : ARMOIRES, MIROIRS ET ECLAIRAGES

Armoire de toilette H75 – P17,5

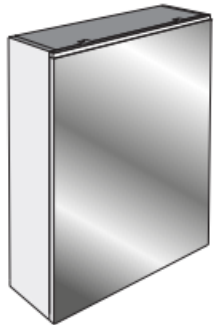

1 porte miroir
L. 60
Bandeau led
Prise électrique



2 portes miroirs
L. 80 / 90
Bandeau led
Prise électrique

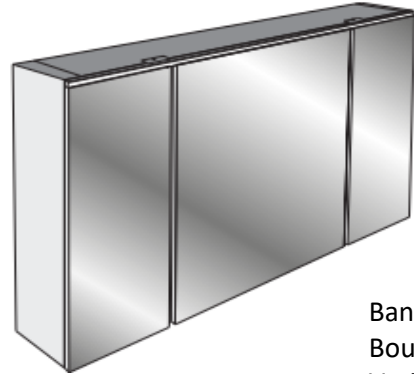

3 portes miroirs
L. 120
Bandeau led
Prise électrique

Bandeau Led
Bouton on/off bluetooth
Variateur d'intensité
Prise électrique
Miroir intérieur

Miroir

Pates de fixation réglables
Chant de couleur assorti aux façades

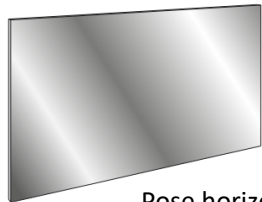

Pose horizontale ou verticale

Rectangulaire
L. 40 / 60 / 80 / 100 / 120
H. 70

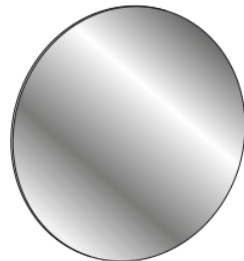

Rond
D. 60 / 90



Pose horizontale ou verticale

Oblong
50 x 90

Eclairage (vendu à part)

L. 30 / 50 / 80

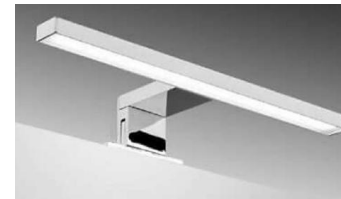

Applique Barre L30cm

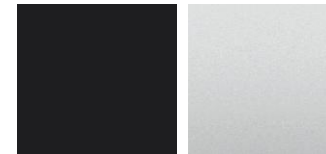

Noir Chrome

* N'est pas compatible avec le miroir rond

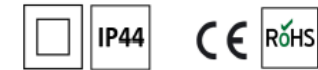

Applique en plastique LED 4,5W
Lumière naturelle 4000K
Alimentation 220V.
Eclairage 380 Lumens
Transformateur intégré.
Cable 60cm
H 6cm x L 30cm x P 10cm

Tablette pour miroir



L. 60 / 80 / 100 / 120

En métal laqué
Se fixe sous le miroir
Profondeur 12cm utile.



Blanc Doré Noir Effet Inox